

2 Find the perimeter of the following shapes (correct to two decimal places where necessary).

Note: you might need to use Pythagoras' theorem in some questions to work out missing sides.

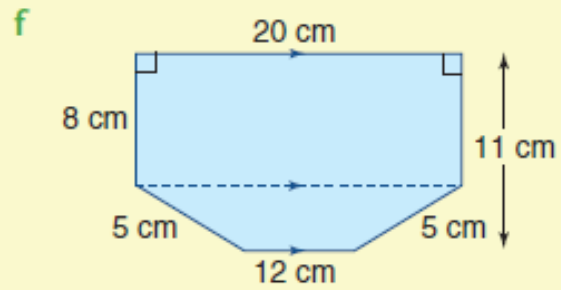

g Segment of circle centre O

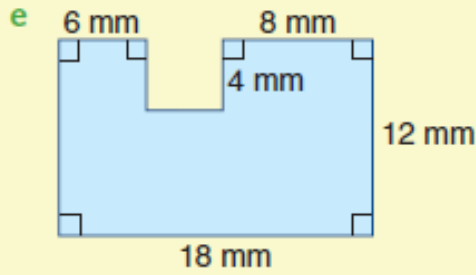
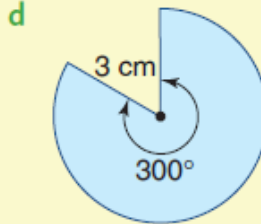
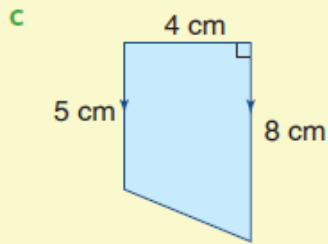
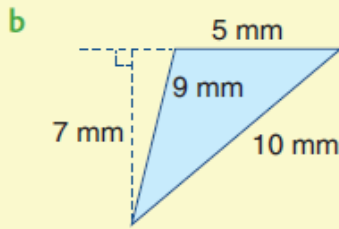
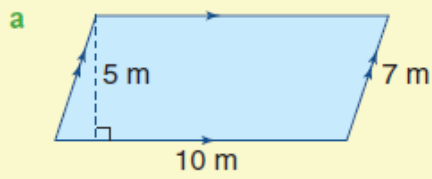
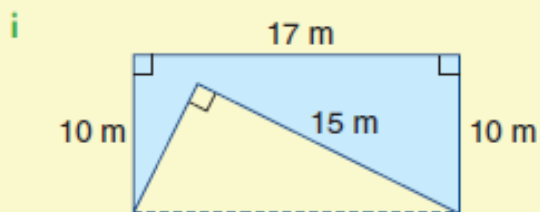
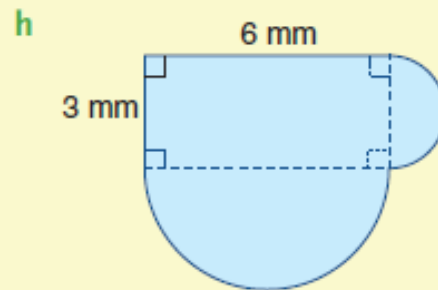
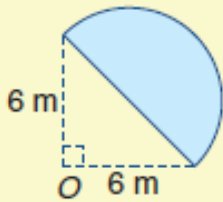

j 2 semi-circles make this shape

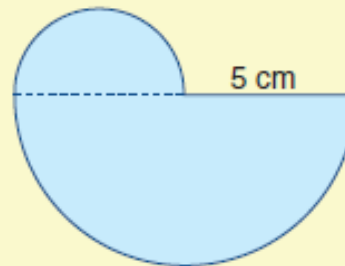

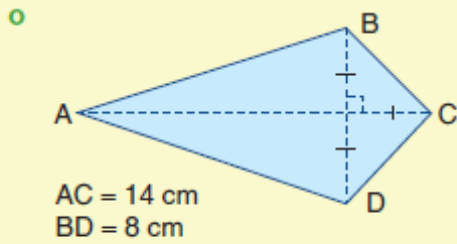
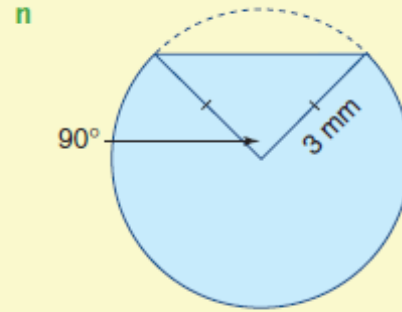
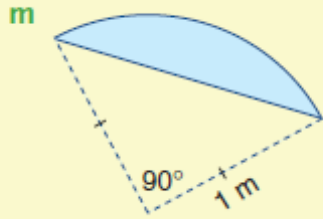
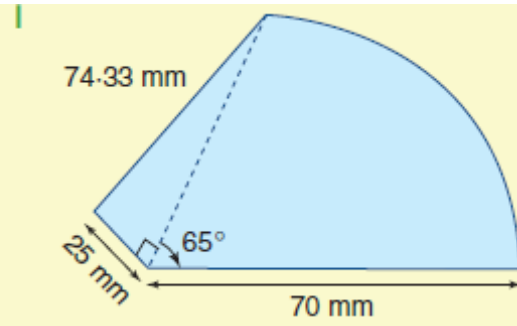
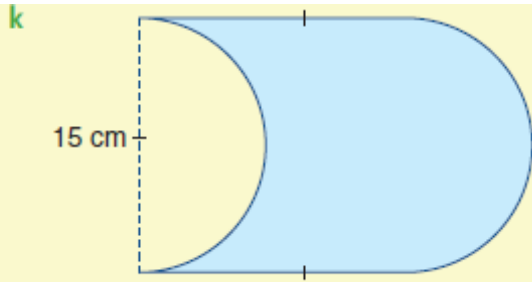

3 Find the area of the shapes in question 2 – find the shaded area where indicated.

1 Find the area of the shaded region:

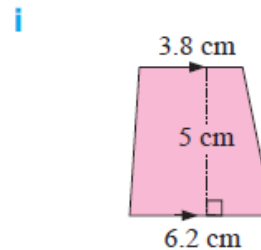
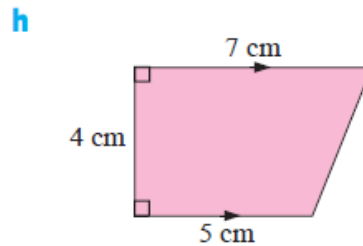
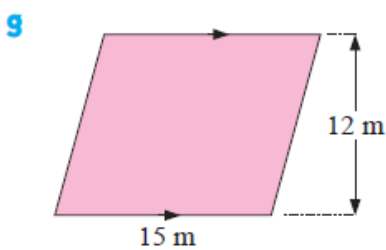
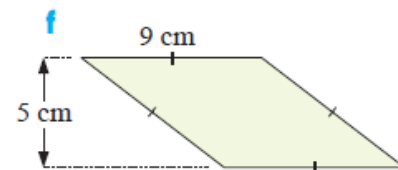
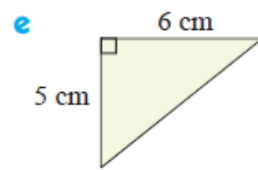
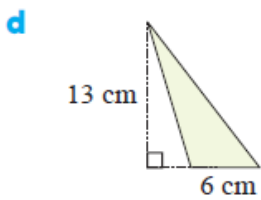
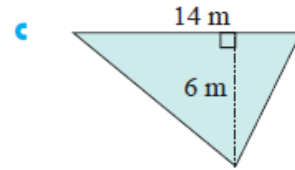
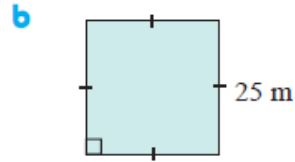
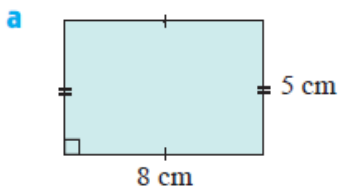

2 Find the area shaded:

a

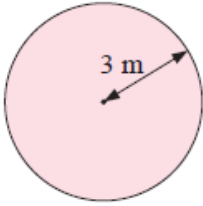

b

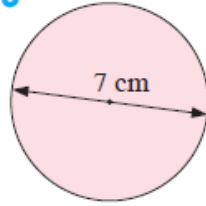

c

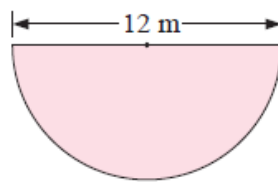

d

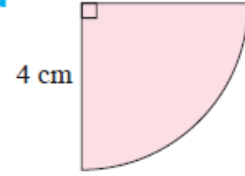

e

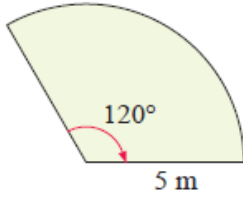

f

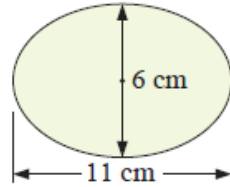

g

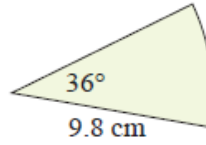

h

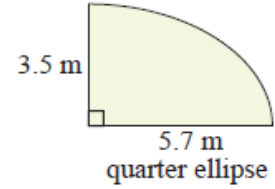

3 Find the area shaded:

a

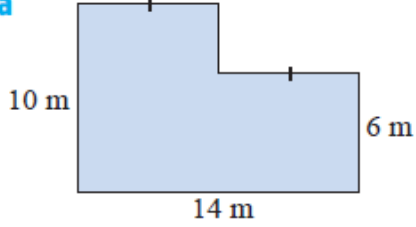

b

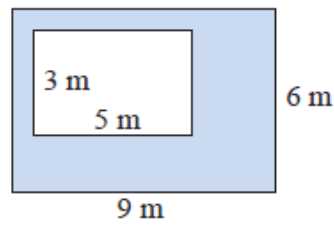

c

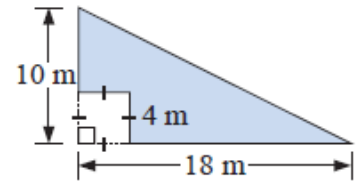

d

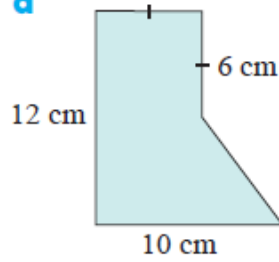

e

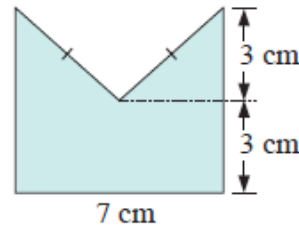

f

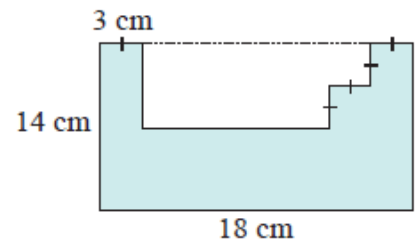

4 Find the area of the shaded regions, giving your answers correct to 2 decimal places:

a

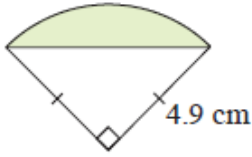

b

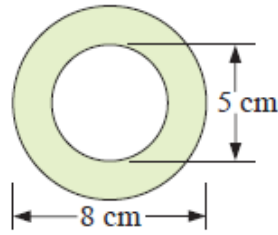

c

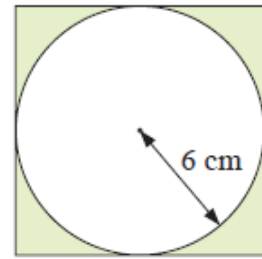

d

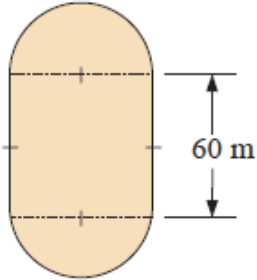

e

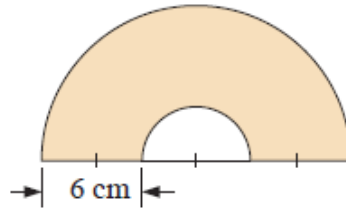

f

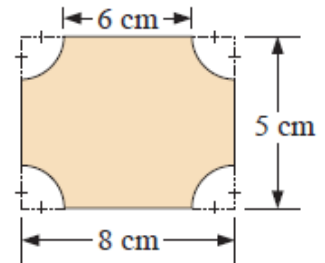

4 Calculate the area of the following composite shapes. All measurements are given in cm.

a

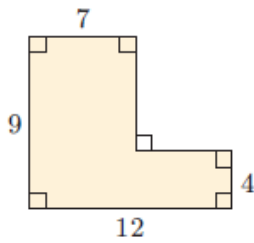

b

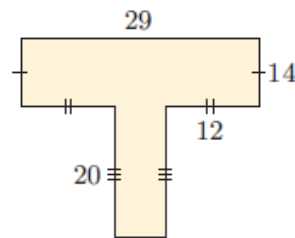

c

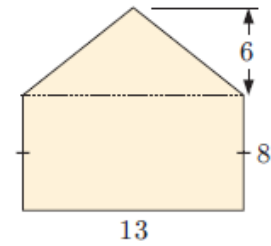

5 Calculate the area of the following shaded regions. All measurements are given in cm.

a

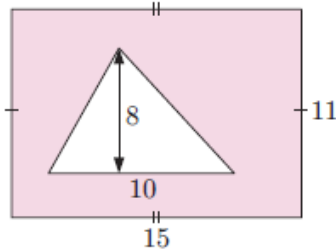

b

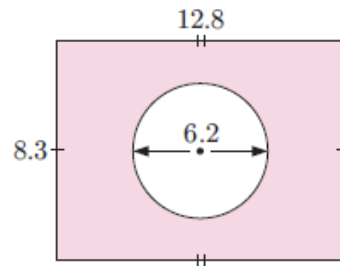

c

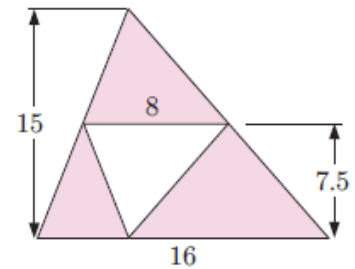

1 Find the total surface area of:

a

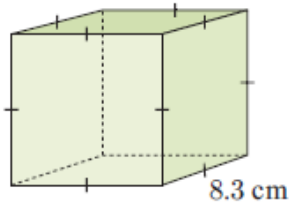

b

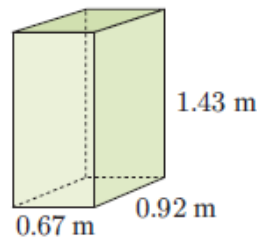

c

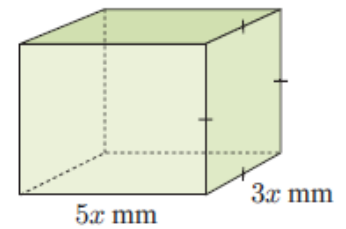

2 Find the total surface area of:

a

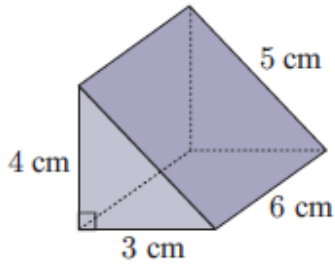

b

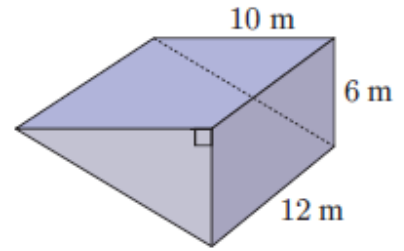

1 Find the surface area of a cube with sides:

a 3 cm

b 4.5 cm

c 9.8 mm

2 Find the surface area of the following rectangular prisms:

a

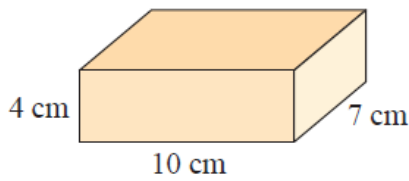

b

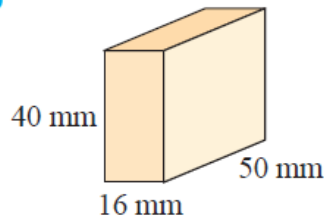

c

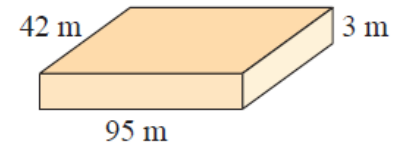

3 Find the surface area of the following triangular prisms:

a

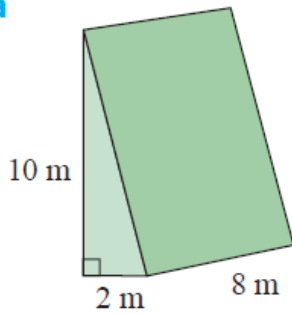

b

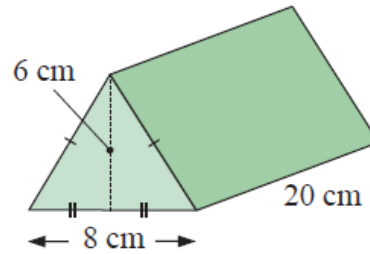

c

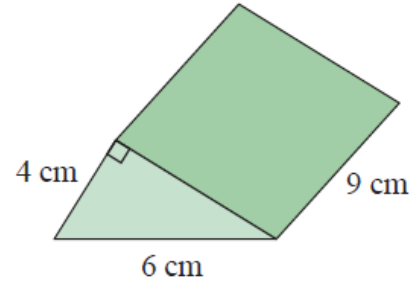

4 Find the surface area of the following prisms:

a

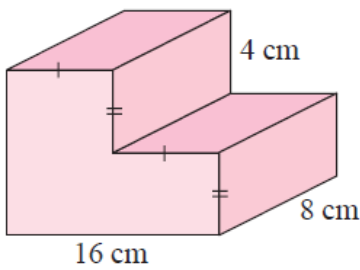

b

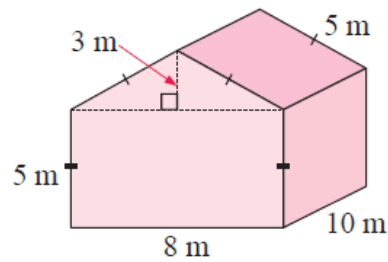

c

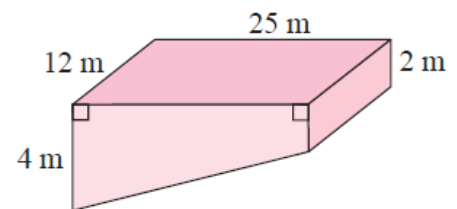

8 Find the outer surface area of the following:

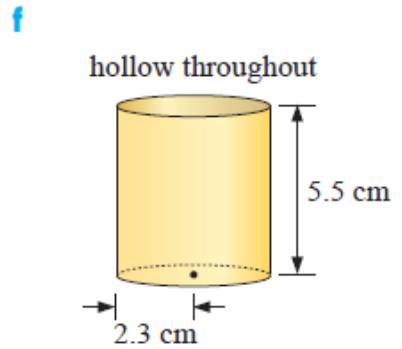
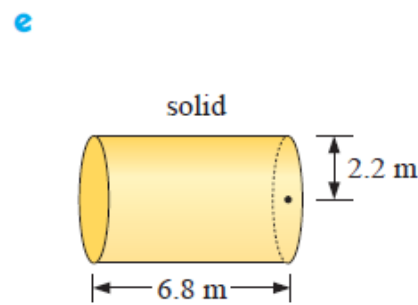
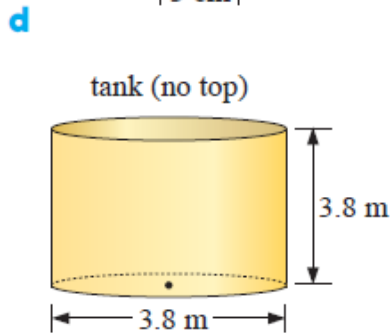
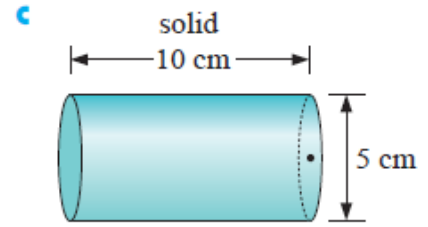
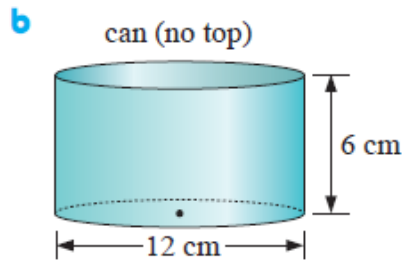
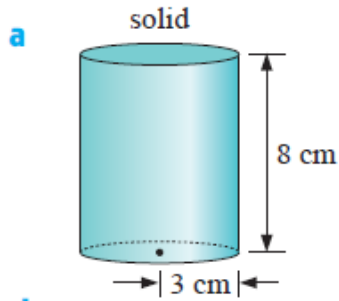

9 Find the total surface area of the following:

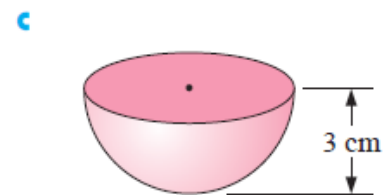
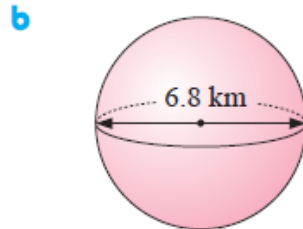
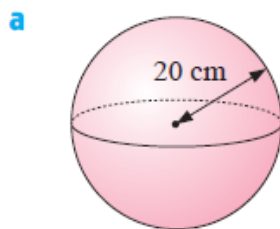

1 Find, correct to 1 decimal place, the outer surface area of the following:

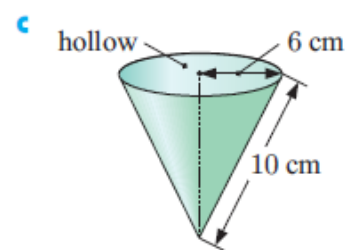
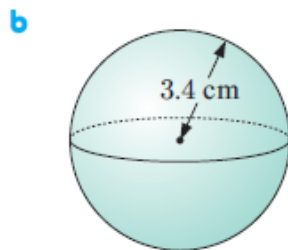
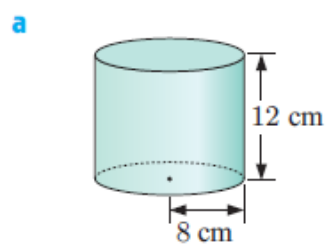

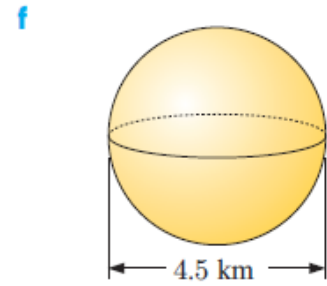
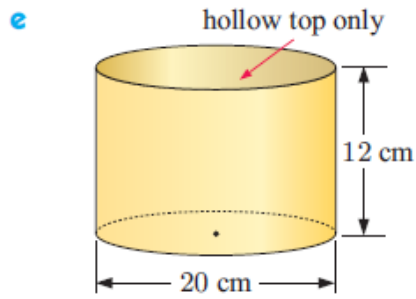
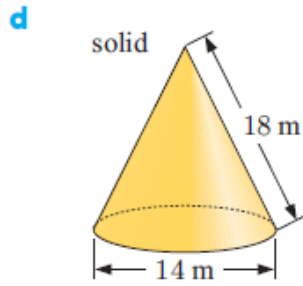

- 2** Find the total surface area of the solid hemisphere shown.

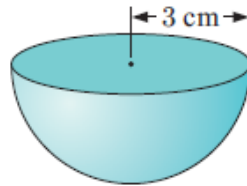

- 1** Find the volume of the following:

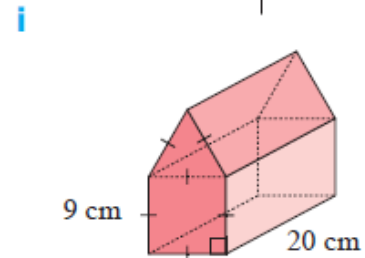
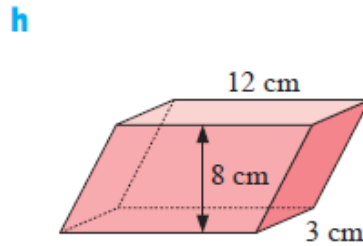
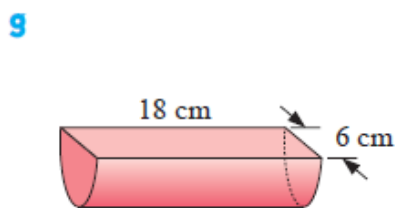
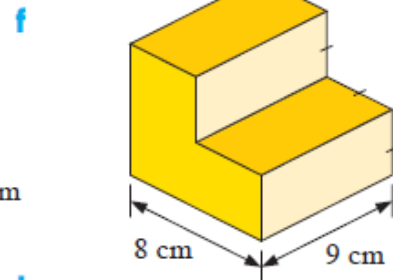
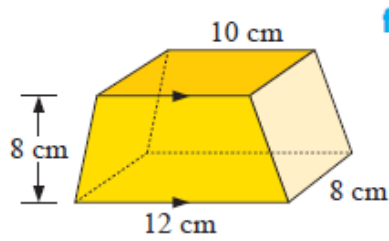
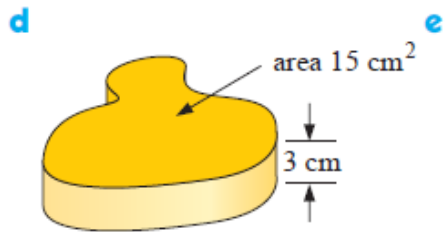
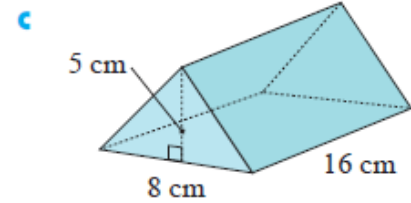
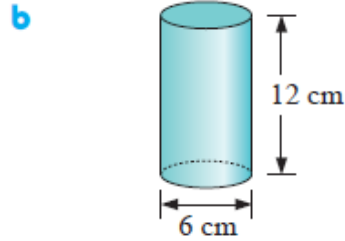
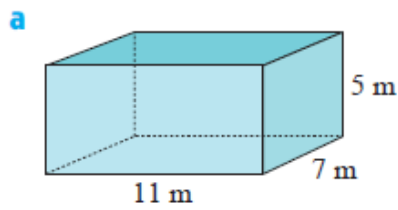

2 Find the volume of the following:

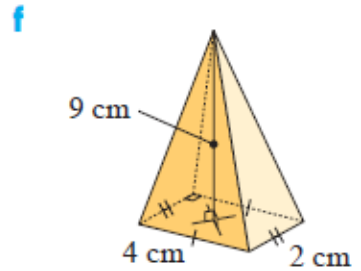
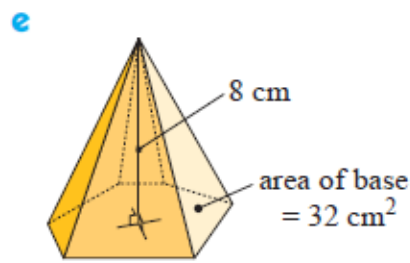
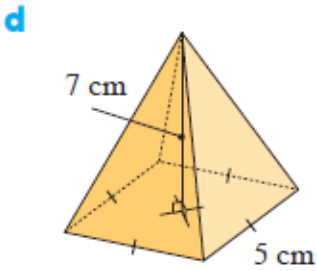
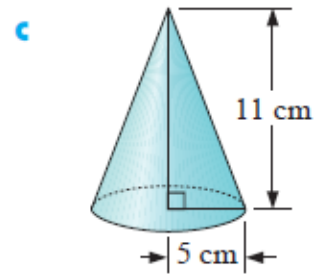
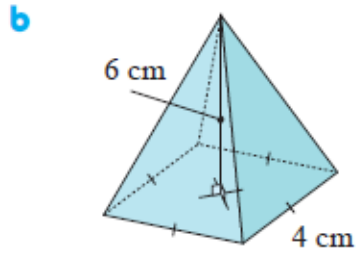
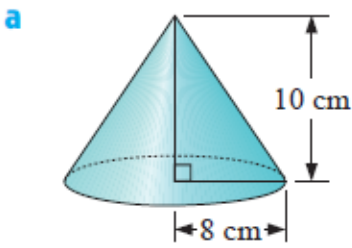

3 Find the volume of the following:

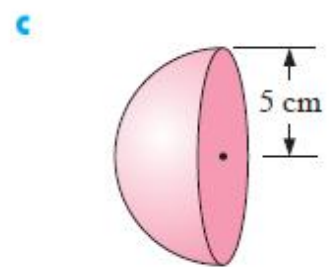
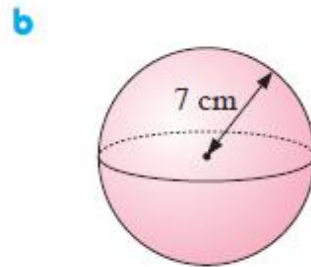
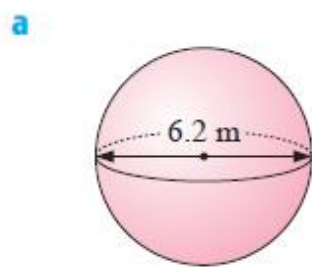

1 Calculate the volume of:

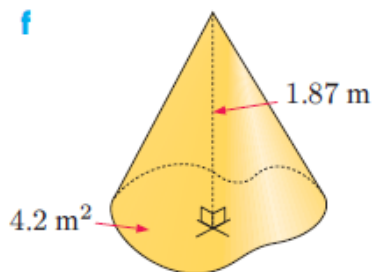
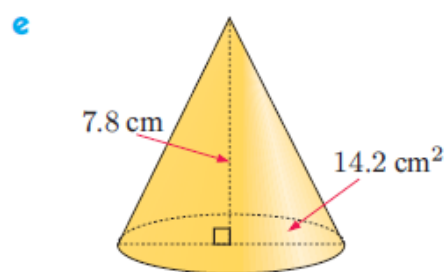
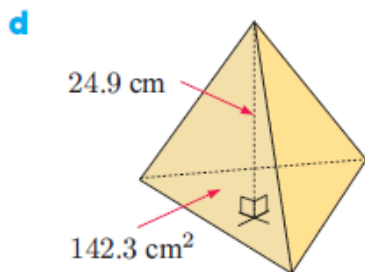
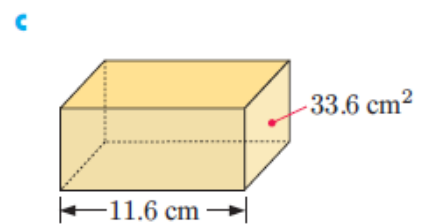
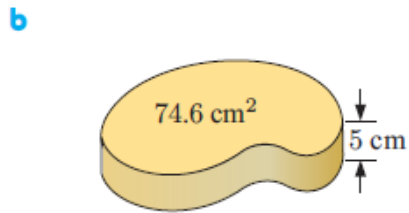
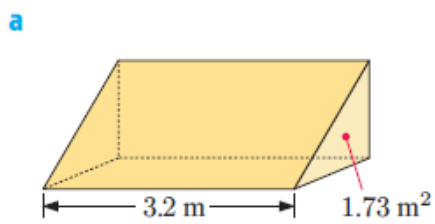

2 Find the volume of:

a

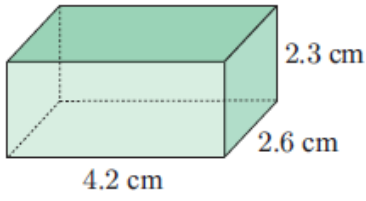

b

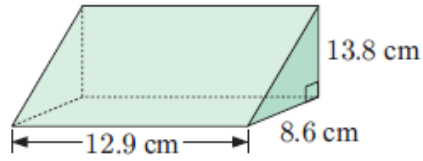

c

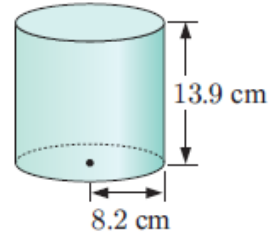

d

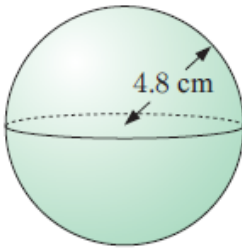

e

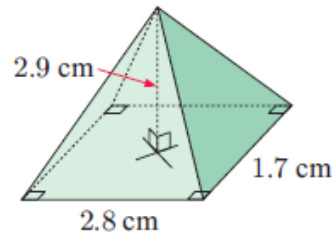

f

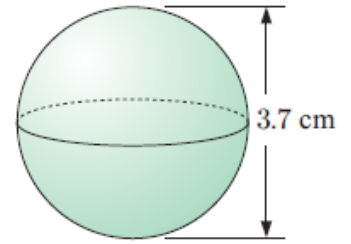

g

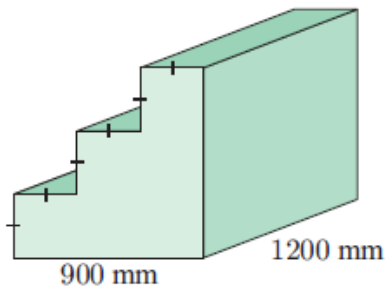

h

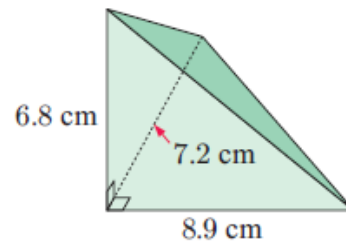

i

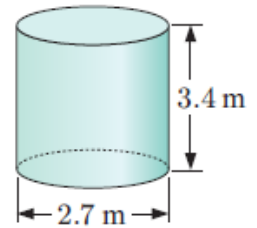

j

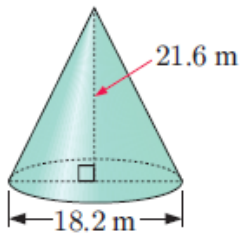

k

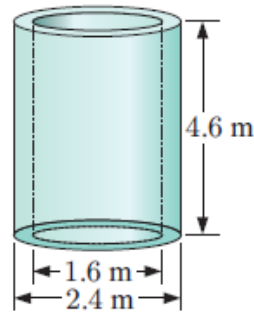

l

